

手術

外来

▼原寸大

先端の図は原寸大

●外科剪刀 (クーパー14cm)

●眼科剪刀 薄刃 (直・反)
(小型外科剪刀)

※ 通常の眼科剪刀より
やや肉薄仕上げです

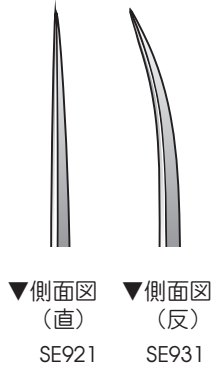

▼側面図 (直) SE921
▼側面図 (反) SE931

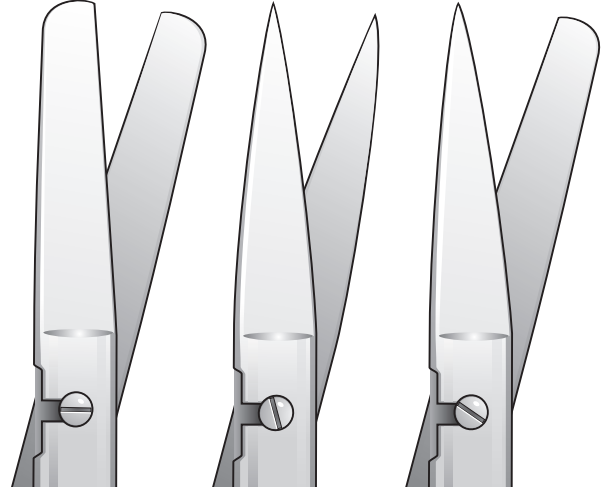
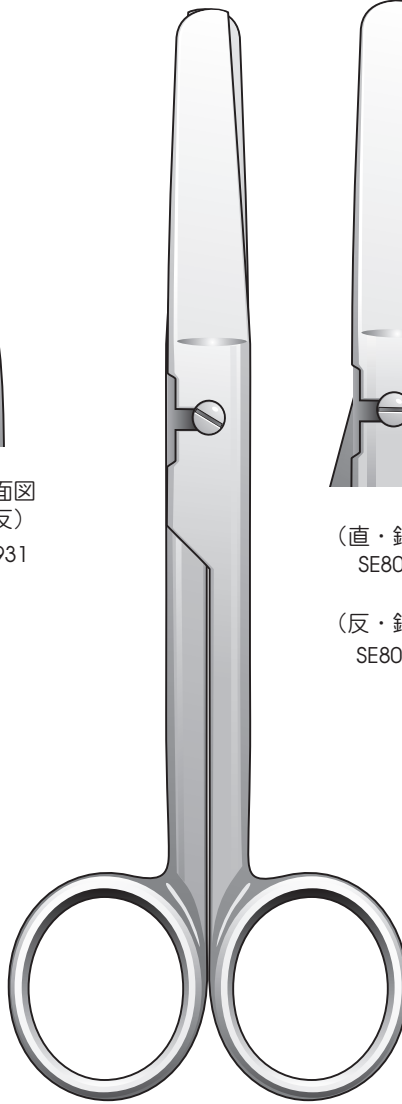

(直・鈍) SE801

(直・鋭) SE802

(直・鈍鋭) SE803

(反・鈍) SE806

(反・鋭) SE807

(反・鈍鋭) SE808

●鼻毛剪刀 (直・反)

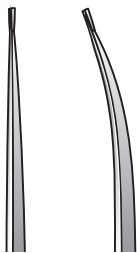

▼側面図 (直) SE901
▼側面図 (反) SE906

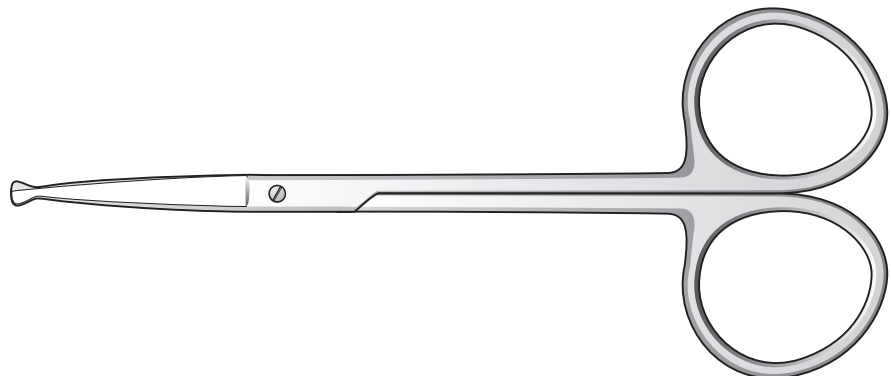

手術 外来 ▼原寸大

先端の図は原寸大

●形成剪刀 (直・反)

▼側面図

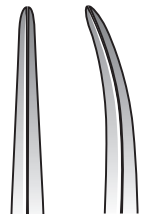
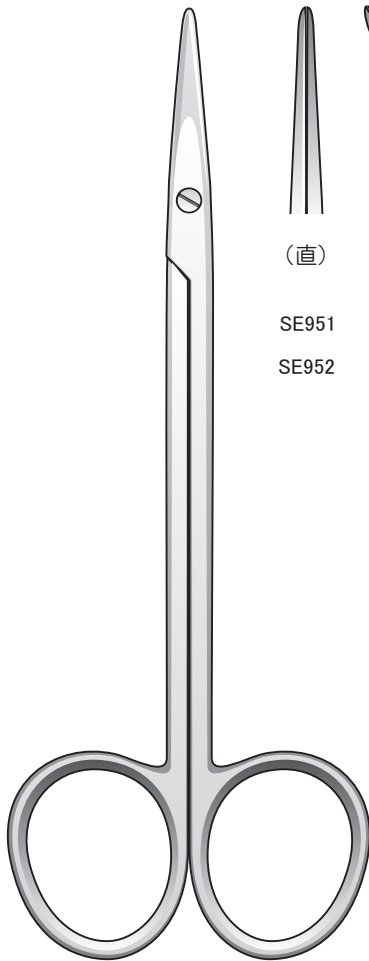

(直)

(反)

SE951 SE956 (125mm)
SE952 SE957 (135mm)

●形成剝離剪刀

▼側面図

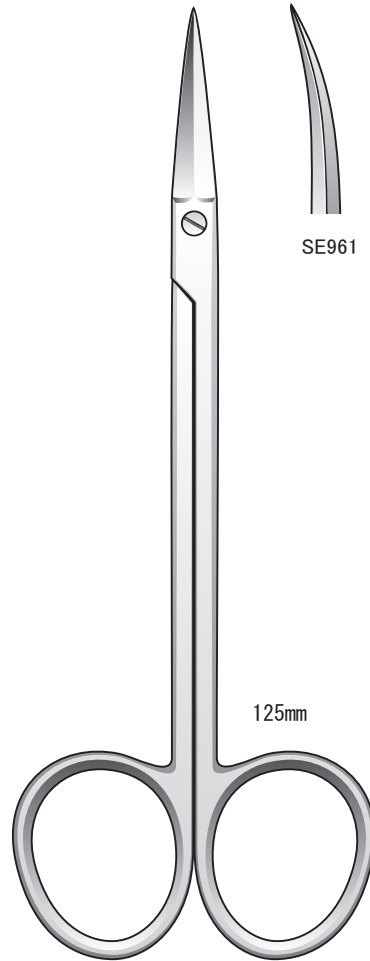

SE961

125mm

